

COIN SLIDE VERTICAL 8 KIT AND SERVICE DOOR LOCK INSTALLATION INSTRUCTIONS FOR GENERAL ELECTRIC KIT COMPONENTS:

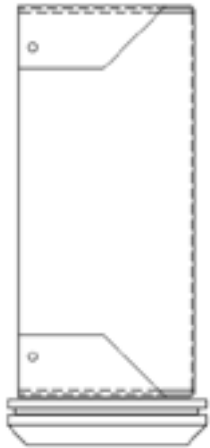

ESD
MONEYBOX

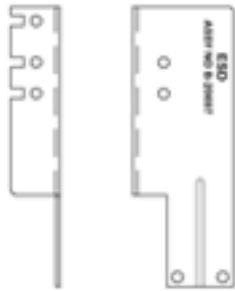

WASHER EXTENSION
PART # 20697

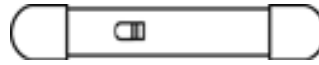

WASHER EXTENSION ARM
PART # 20698



DRYER EXTENSION
PART # 21420

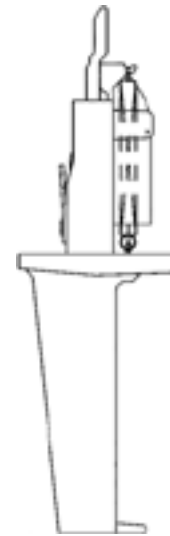

COIN SLIDE V8-2000

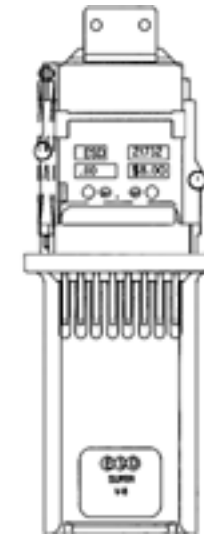

MOUNTING BOLT
PART # 21748

WASHER KIT CONSISTS OF

- 1 COIN SLIDE (V8-200)
 - 1 MONEY BOX (LMB w/ Key)
 - 1 MOUNTING BOLT #21748
 - 1 EXTENSION #20697
 - 1 EXTENSION ARM #20698
 - 2 SCREWS #10-32 PAN HEAD #50035
- SERVICE DOOR LOCK w/KEY & CAM NOT INCLUDED (0400ET)**

DRYER KIT CONSISTS OF

- 1 COIN SLIDE (V8-200)
 - 1 MONEY BOX (LMB w/ Key)
 - 1 MOUNTING BOLT #21748
 - 1 EXTENSION #21420
 - 2 SCREWS #10-32 PAN HEAD #50035
- SERVICE DOOR LOCK w/KEY & CAM NOT INCLUDED (0400ET)**

LOCK, KEY & CAM

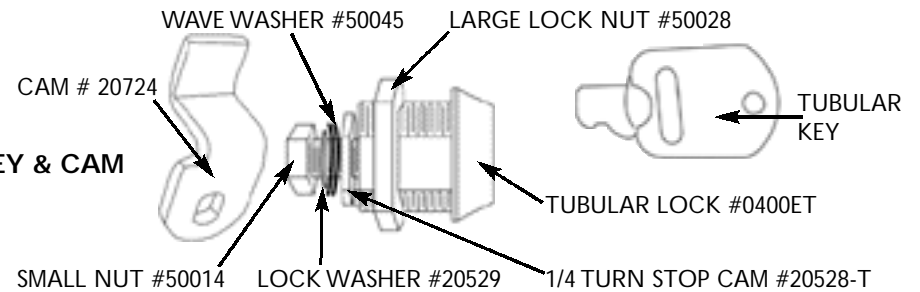

STEP 1: COIN SLIDE EXTENSION ASSEMBLY

FIG. #1
WASHER COINSLIDE ASSEMBLY

FIG. #2
DRYER COINSLIDE ASSEMBLY

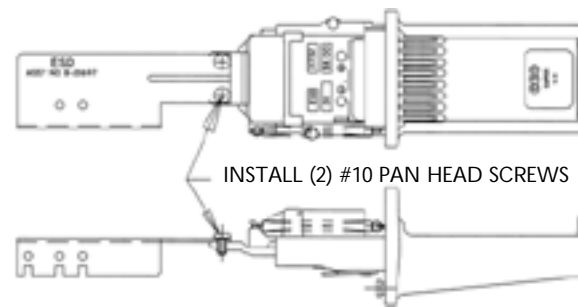

MOUNT WASHER EXTENSION #20697 TO COIN SLIDE

FIG. # 1

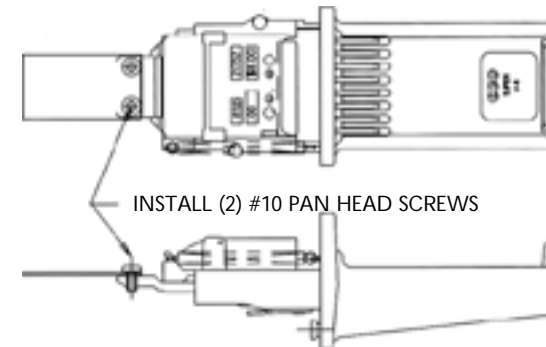

MOUNT DRYER EXTENSION #21420 TO COIN SLIDE

FIG. # 2

DISCONNECT ELECTRICAL POWER BEFORE INSTALLATION

STEP 2:

- INSERT KEY INTO MONEY BOX - TURN KEY TO OPEN POSITION (UNLOCKED)
- INSTALL MONEY BOX IN METER CASE AS INDICATED BY ARROW FIG #3
- LOCK MONEY BOX TO SECURE

STEP 3:

- INSTALL COINSLIDE WITH EXTENSION (SEE FIG #1 FOR WASHER)
(SEE FIG. #2 FOR DRYER)

STEP 4:

- SECURE COINSLIDE WITH MOUNTING BOLT (#21748) BY INSERTING THE MOUNTING BOLT THROUGH THE SERVICE DOOR OPENING ON SIDE OF METER CASE, GUIDING THROUGH MOUNTING BOLT GUIDE AND TIGHTEN TO SECURE COIN SLIDE. USE A 5/16 SOCKET AND RATCHET (DO NOT OVER-TIGHTEN)

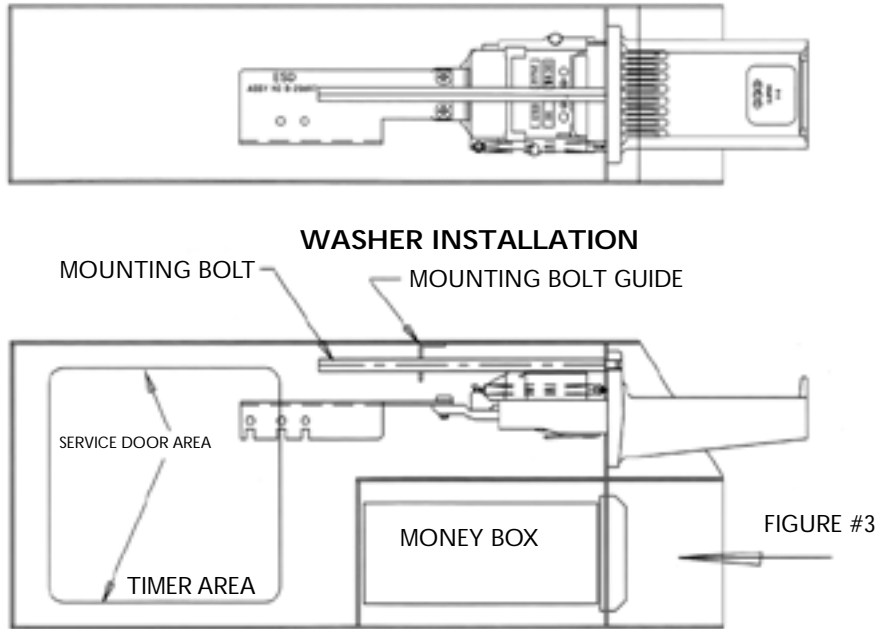

STEP 5:

- THROUGH SERVICE DOOR OPENING INSTALL EXTENSION ARM IN POSITION SHOWN TAKE TO LOCATE TAB IN NOTCH ON SIDE OF EXTENSION
- INSTALL #10 PAN HEAD SCREW
- CHECK COINSLIDE FOR FREE TRAVEL
- REPLACE SERVICE DOOR AND CONNECT ELECTRIC

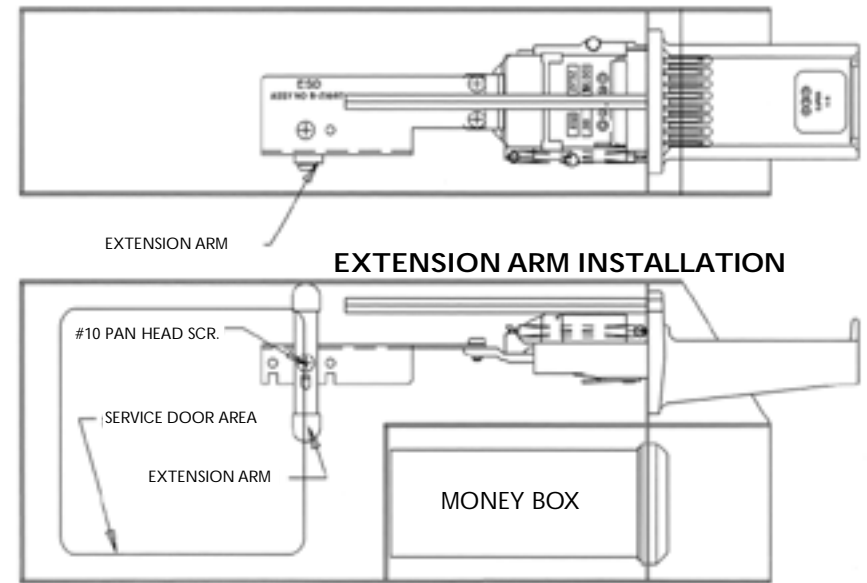

STEP 6:

- REMOVE 3/4 INCH NUT (LARGE #50028) FROM LOCK
- REMOVE 9/32 INCH NUT (SMALL #50014) FROM TAIL OF LOCK
- REMOVE LOCK WASHER (#20529) FROM TAIL OF LOCK
- DO NOT REMOVE (2) WAVE WASHERS (#50045) FROM TAIL OF LOCK
- INSERT LOCK THROUGH SERVICE DOOR PANEL HOLE
- ATTACH 3/4 INCH NUT (LARGE #50028), TIGHTEN TO SECURE TO PANEL
- FASTEN CAM (#20724) ONTO TAIL OF LOCK SECURING CAM WITH LOCK WASHER AND SMALL NUT. (OFFSET SIDE DOWN)

VERTICAL 8 PRICE CHANGE INSTRUCTIONS

- STEP 1:** UNHOOK RETURN SPRING (#22)
- STEP 2:** PUT COINS IN HANDLE, PUSH HANDLE (#2) IN UNTIL COINS DROP THROUGH COINSLIDE
- STEP 3:** WHILE HOLDING HANDLE IN, LOOSEN SPRING BRACKET SCREW (#24)
- STEP 4:** REMOVE FUNCTIONAL INSERTS (#27) FROM CAVITY OF COINSLIDE HANDLE (SUGGESTION, STORE ALL INSERTS IN BULK FOR FUTURE USE)
- STEP 5:** RETIGHTEN SPRING BRACKET SCREW (#24)
- STEP 6:** FLIP COIN SLIDE UPSIDE DOWN, REMOVE THREE INSERT RETAINER PLATE SCREWS (#8) FROM UNDERSIDE
- STEP 7:** EXCHANGE BLANK INSERTS WITH FUNCTIONAL INSERTS

REVERSE INSTRUCTIONS TO RE-ASSEMBLE

ITEM	PART #	DESCRIPTION
1	21728	BODY
2	21727	HANDLE
3	21732	BRIDGE
4	20059	RATCHET
5	20065	RATCHET SPRING
6	20664	RETAINER SPRING
7	20736	RATCHET SCREW
8	21209	INSERT RETAINER PLT. SCREW
9	21738	INSERT RETAINER PLATE
10	21216	BLANK INSERT
11	20709	BOTTOM PLATE
12	50034	BOTTOM PLATE SCREW
13	20710	PIVOT PIN
14	20181	LEVER
15	20717	LEAF SPRING
16	21210	RATCHET PLATE
17	21881	GATE
18	21866	GATE RETAINER

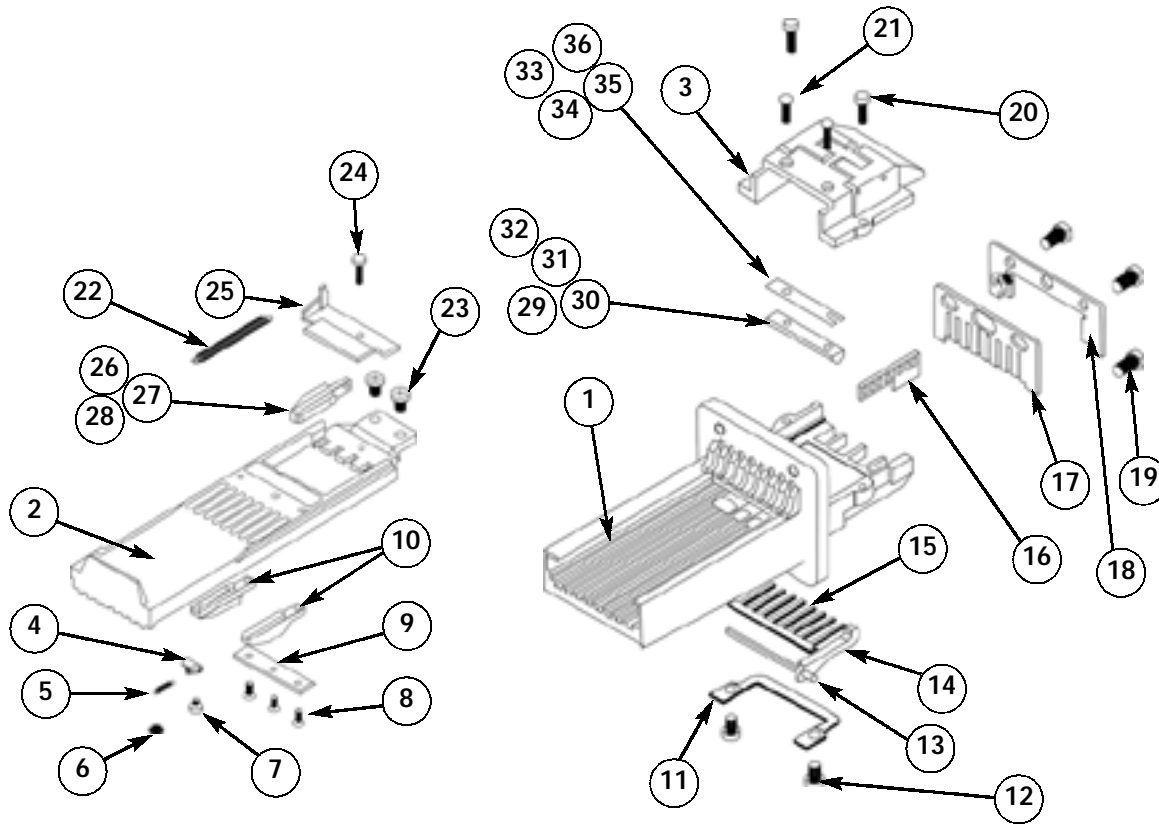

ITEM	PART #	DESCRIPTION
19	20185	LOCATION SCREW
20	50033	BRIDGE SCREW
21	20662	BRIDGE INSERT SCREW
22	21771	RETURN SPRING
23	50035	EXTENSION SCREW
24	50032	SPRING BRACKET SCREW
25	21860	SPRING BRACKET
26	21194	10¢ INSERT
27	21193	25¢ INSERT
28	21281	\$1.00 INSERT
29	21758	\$1.85 BRIDGE INSERT
30	21759	\$2.00 BRIDGE INSERT
31	21760	\$2.75 BRIDGE INSERT
32	21765	\$5.75 BRIDGE INSERT
33	20732	.010 SHIM
34	20733	.015 SHIM
35	20734	.020 SHIM
36	20735	.030 SHIM